



Tile Cutters

CUT & MARK TOOLS



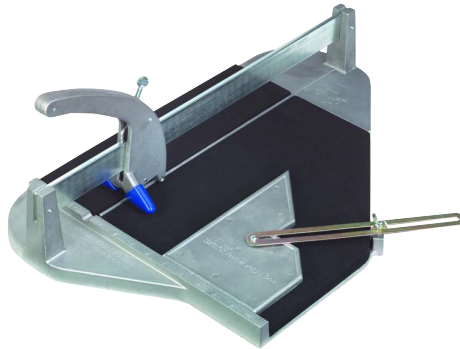

ITEM NO. 82-10

CUTTING CAPACITY	
RIP CUT	DIAGONAL CUT
 10" TILE	 7" TILE



ITEM NO. 82-17

CUTTING CAPACITY	
RIP CUT	DIAGONAL CUT
 17" TILE	 12" TILE

die-cast aluminum base

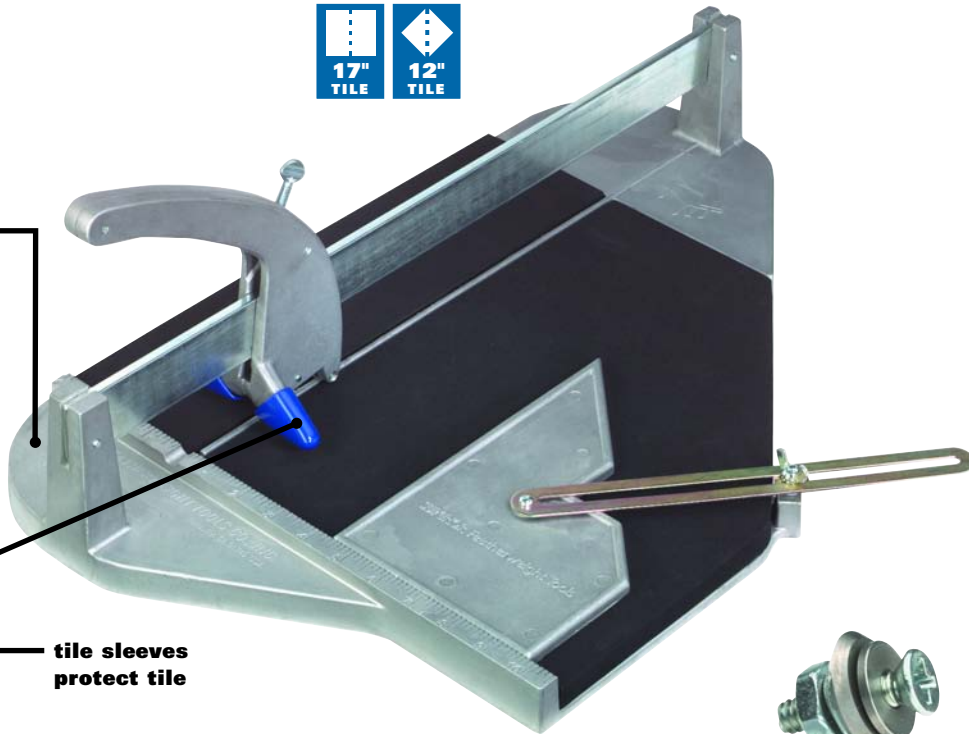

tile sleeves protect tile

PROBILT SERIES™ SLIDE BAR TILE CUTTERS

ITEM NO.	CUTTING CAPACITY		PKG.
	RIP	DIAGONAL	
82-10	10"	7" Tile	1
82-17	17"	12" Tile	1

SPECIFICATIONS

Scoring Wheel	1/2" Carbide
Handle	Interchangeable Handle w/Spring
Bearings	None
Base	Die Cast Aluminum

PROBILT SERIES™ SCORING WHEEL

- Replacement Scoring Wheel for Tile Cutters
- Titanium coated carbide
- Hardware included

ITEM NO.	DESCRIPTION	PKG.
82-400	1/2" Scoring Wheel	12

Replacement Scoring Wheel: 82-400

SUPERIORBILT.



CALL TO ORDER 800-272-8786 FAX 800-200-7765



ITEM NO. 81-17

TRUE CAPACITY	
RIP CUT	DIAGONAL CUT
18" TILE	12" TILE



ITEM NO. 81-20

TRUE CAPACITY	
RIP CUT	DIAGONAL CUT
20" TILE	14" TILE



ITEM NO. 81-25

TRUE CAPACITY	
RIP CUT	DIAGONAL CUT
25" TILE	18" TILE



ITEM NO. 81-28

TRUE CAPACITY	
RIP CUT	DIAGONAL CUT
28" TILE	20" TILE

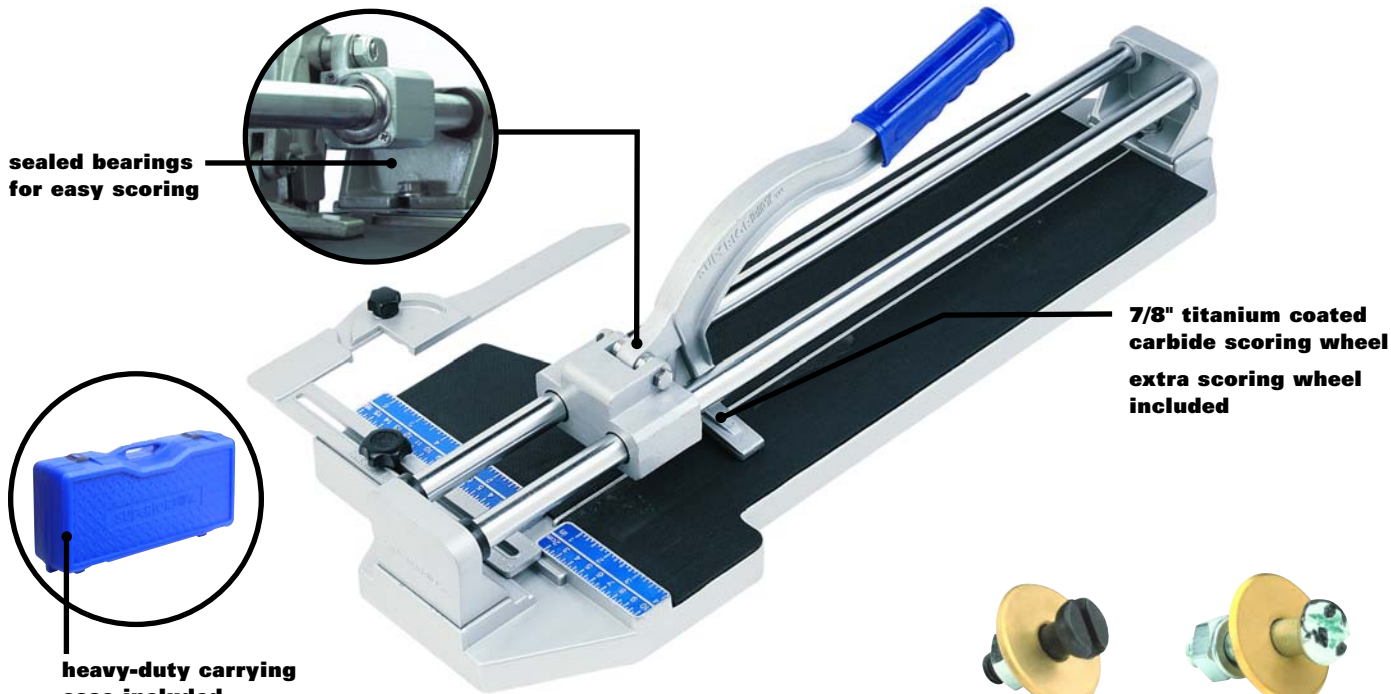

**PROBILT SERIES™
TWO-BAR
TILE CUTTERS**

ITEM NO.	CUTTING CAPACITY RIP	DIAGONAL	PKG.
81-17	18"	12" Tile	1
81-20	20"	14" Tile	1
81-25	25"	18" Tile	1
81-28	28"	20" Tile	1

SPECIFICATIONS	
Scoring Wheel	7/8" Titanium Coated Carbide
Handle	Curved
Rip Guide	Protractor
Bearings	Sealed
Steel Bars	25/32" (3/4") Chrome, Hardened
Extra Scoring Wheel	Yes
Carrying Case	Yes

**PROBILT SERIES™
SCORING WHEELS**

- Replacement Scoring Wheels for Tile Cutters
- Titanium coated carbide
- Hardware included

ITEM NO.	DESCRIPTION	PKG.
81-TSW	7/8" Scoring Wheel	12
81-045B	7/8" Scoring Wheel	12



Replacement Scoring Wheels: 81-TSW or 81-045B (interchangeable)

SUPERIORBILT.

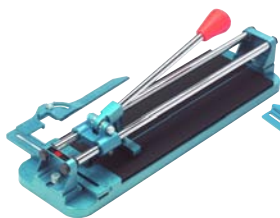





ITEM NO. 81-045J

CUTTING CAPACITY	
RIP CUT	DIAGONAL CUT
 17" TILE	 12" TILE



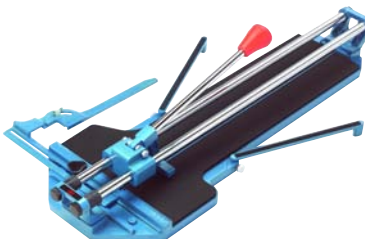

ITEM NO. 81-050J

CUTTING CAPACITY	
RIP CUT	DIAGONAL CUT
 22" TILE	 16" TILE



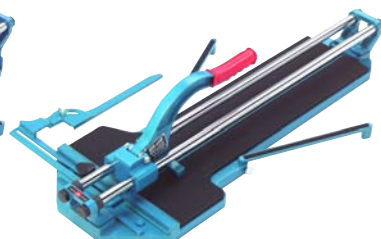

ITEM NO. 81-600J

CUTTING CAPACITY	
RIP CUT	DIAGONAL CUT
 26" TILE	 18" TILE



ITEM NO. 81-600JR

CUTTING CAPACITY	
RIP CUT	DIAGONAL CUT
 25" TILE	 18" TILE

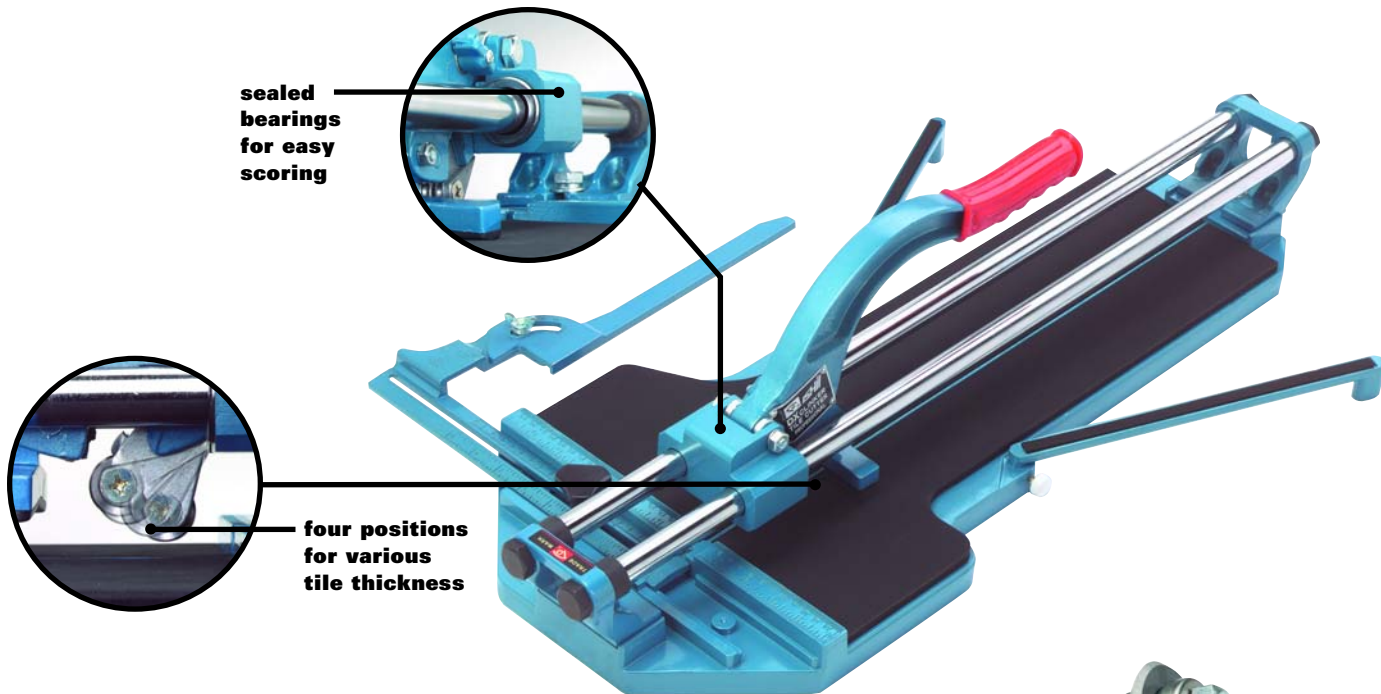

sealed bearings for easy scoring

four positions for various tile thickness



MIKI® TWO-BAR TILE CUTTERS

ITEM NO.	CUTTING CAPACITY RIP	CUTTING CAPACITY DIAGONAL	PKG.
81-045J	17"	12" Tile	1
81-050J	22"	16" Tile	1
81-600J	26"	18" Tile	1
81-600JR	25"	18" Tile	1

81-050J and 81-600JR have curved handle

Replacement Scoring Wheel: 81-045JB

SPECIFICATIONS

Scoring Wheel	7/8" Carbide
Bearings	Sealed
Steel Bars	25/32" (3/4") Chrome, Hardened

SCORING WHEEL

- Replacement Scoring Wheels with bearings for Miki Tile Cutters
- Hardware included

ITEM NO.	DESCRIPTION	PKG.
81-045JB	7/8" Scoring Wheel	6

SUPERIORBILT®



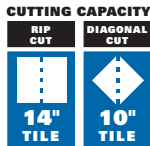
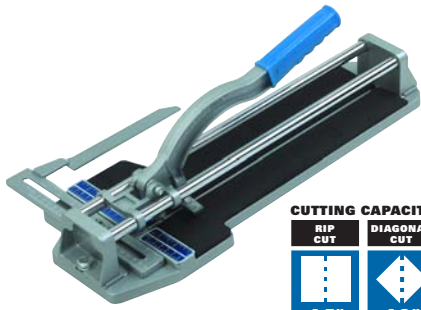

**SELECTSERIES™
TWO-BAR TILE CUTTER**

- Heavy-duty, die-cast aluminum base
- Dual chrome-plated, rugged steel rails
- Adjustable measuring gauge
- Equipped with replaceable 7/8" carbide scoring wheel
- Designed for cutting all types of ceramic tile

ITEM NO.	CUTTING CAPACITY		PKG.
	RIP	DIAGONAL	
81-M13	14"	10" Tile	1

Replacement Scoring Wheel: 81-045B



SCORING WHEEL

- Replacement Scoring Wheels for Tile Cutters
- Titanium coated carbide
- Hardware included
- Includes extra bolt for Two-Bar Tile Cutter

ITEM NO.	DESCRIPTION	PKG.
81-045B	7/8" Scoring Wheel	12



HAND TILE CUTTER

- Ideal for cutting curves and free-form designs in tile
- 1/2" carbide scoring wheel
- Straight or curved cuts
- Attached breaker assembly separates tile at score line

ITEM NO.	DESCRIPTION	PKG.
82-RN1500	Hand Tile Cutter	12



**PROBILT SERIES™
10" PORCELAIN
EXTREME
DIAMOND BLADE**

- Specifically designed for smooth cutting of porcelain tile, also cuts tile, marble, granite and stone
- Smoothest wet cut
- 5/8" arbor

ITEM NO.	DESCRIPTION	PKG.
82-425-10	10" Porcelain Extreme Diamond Blade	1

ITEM NO. 83-821A



ITEM NO. 83-41A



RUBBING STONES

- Smooth rough edges on freshly cut tile
- Use to dress diamond blades
- White stones will not mark tile

ITEM NO.	DESCRIPTION	PKG.
83-821A	8" x 2" x 1" Rubbing Stone	6
83-41A	4" x 1" Round Rubbing Stone	6



ITEM NO. 80-2150

ITEM NO. 80-3150

WATER HEATERS

- Under extreme cold conditions, quickly warms tile saw water
- Heats 1 gallon of room temperature water to 90° in 10 minutes
- UL Approved



ITEM NO.	DESCRIPTION	PKG.
80-2150	5-1/2" Water Heater	1
80-3150	11-1/2" Water Heater	1

